



(

)

PISTOCHE!

3

I.1	3
I.2	PISTOCHE.....	3

4

5

II.1	PISTOCHE.....	5
II.2 PISTOCHE –	6
II.3	8
II.4	9
II.5	, PISTOCHE.....	9

10

III-1	PISTOCHE	10
III-2	PISTOCHE	17
III-3	19
III-4	– 0,5	21
III-5	22
III-6	24

26

27

V-1	27
VIII.2	27
VIII.3	27
VIII.4	27
VIII.5	28

29

IX.1	29
IX.2	29

30

X.1	0,5 : 2	30
X.2	: 2	30
X.3	: 2 ; 1	30
X.4	: 1	31
XI.5	31



PISTOCHE!

I.1

Pistoche

0,5

, 450 / ²,

I.2

PISTOCHE

: 2,3 x 2,3

: 0,67

58 : 2320

58 : 2270

230 ² / 12 ³ / ,
5 AC

40

58

Pistoche

, 2

PEFC.





Two horizontal lines for writing.

!

, (,)
 ,
 ,
 ;
 ;
 , () , ,
 ;
 , ,
 Pistoche (,),
 (, ,)
 Pistoche - ,
 ;
 ;
 (, ,)
 ;
 12 3,5
 ;

-
-
-
-
-
-
-
-

II.1

PISTOCHE

1 ():
 : 0,4 x 0,4 x 0,6
 : 10
 :
 • 0,5
 •
 •
 •
 •



2 ():
 : 2,30 x 0,61 x 0,45
 : 150
 :
 •
 •
 •
 •





1/2

II.2 PISTOCHE –

FILTRATION

101	2x35	-
		24

102	5x60	-
		95

103	4x35	-
		8

104	4x20	-
		24

105	4x20	-
		95

106	torx 6x25	-
		16

214	150	-
		6

219		-
		2

220		-
		4

300		-
		1

301		-
		1

302		-
		1

303		-
		1

304		-
		1

305		-
		1

306		-
		1

307		-
		1

308		-
		1

309		-
		2

310		-
		4

400		-
		2

401		-
		2

402		-
		8

403		-
		2

404		-
		6

500		-
		1

501		-
		4



200	2203x68x28	-
		2

201	2203x77x28	-
		2

202	2130x145x28	-
		2

203	2203x145x28	-
		14

204	IV 2204x132x28	-
		4

205	2076x86x28	-
		3

206	2203x127x28	-
		1

207	2187x74x28	-
		1

208	634x86x58	-
		6

209	535x86x58	-
		2

210	584x17x44	-
		6

211	485x17x44	-
		2

212	IV 2099x145x28	-
		4

213	1688 mm	-
		3

215	, 1988	-
		1

216	, 1988	-
		1

217	1980	-
		4

218		-
		1

405		-
		1

II.3

2 : 4



4



T-20 - T-25 - T-30



15 25°C



II.4

- Pistoche
- Pistoche
- Pistoche
- Pistoche

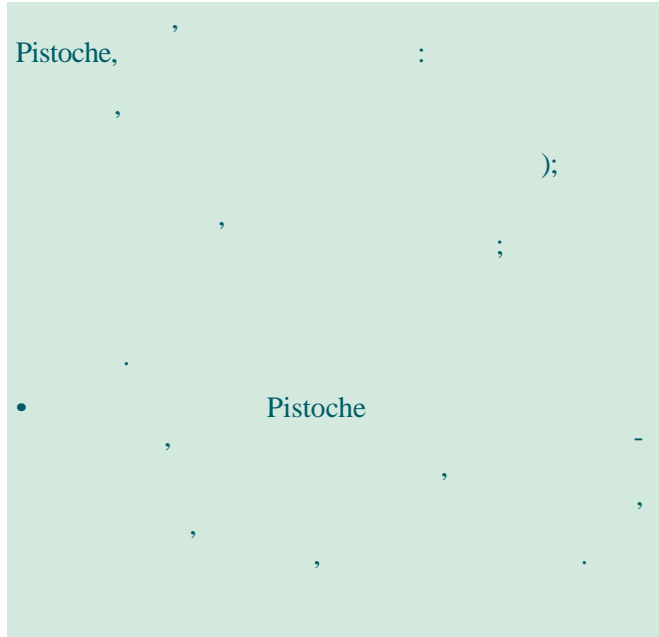

II.5 PISTOCHE

Pistoche;



III-1

PISTOCHE

201	×2
203	×2
204	×4

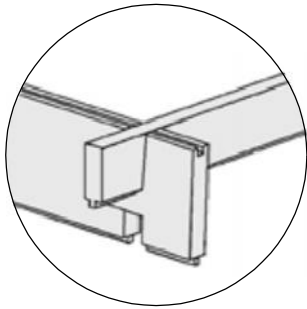

102	×12
-----	-----

5x60.

12

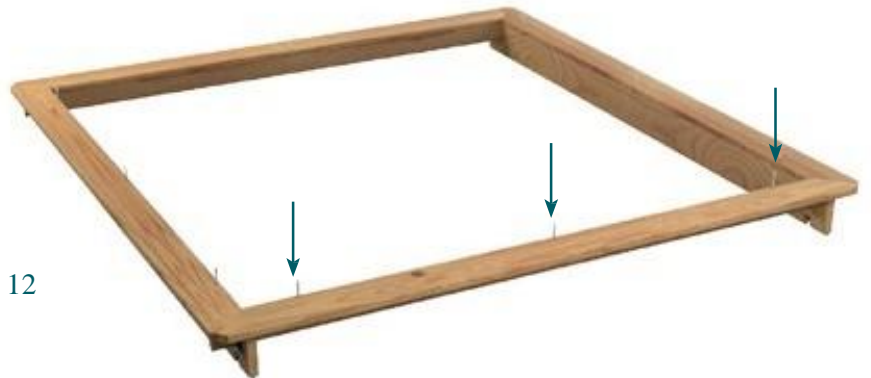

220	×4
106	×16





208	×6
209	×2
102	×16

(204)

(208 209)



(203).

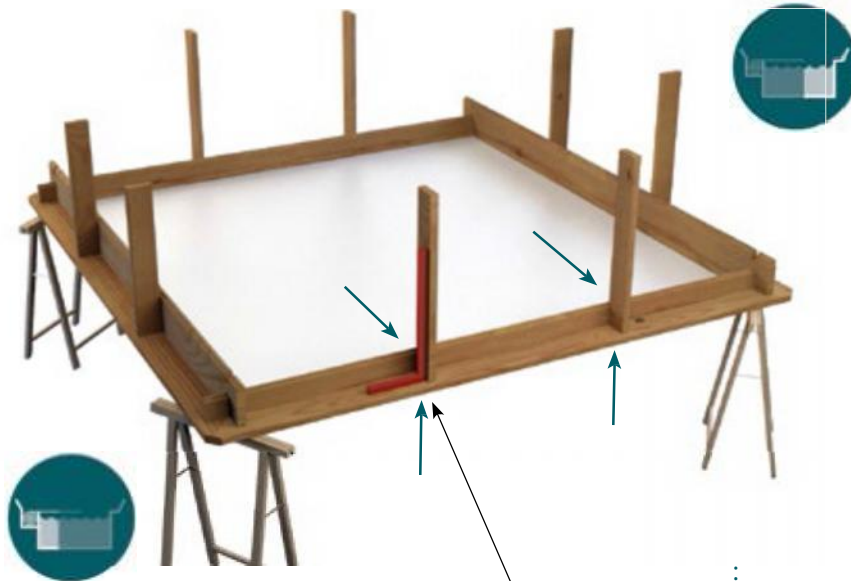

203 ×4



203 ×8
202 ×2



200 ×2





(208 209) -
(204).



102 x20

2

3

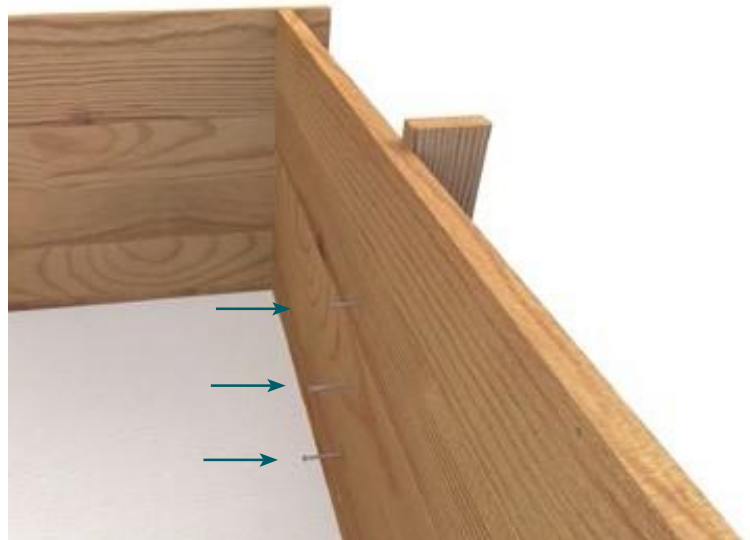



H 4-
Pistoche.

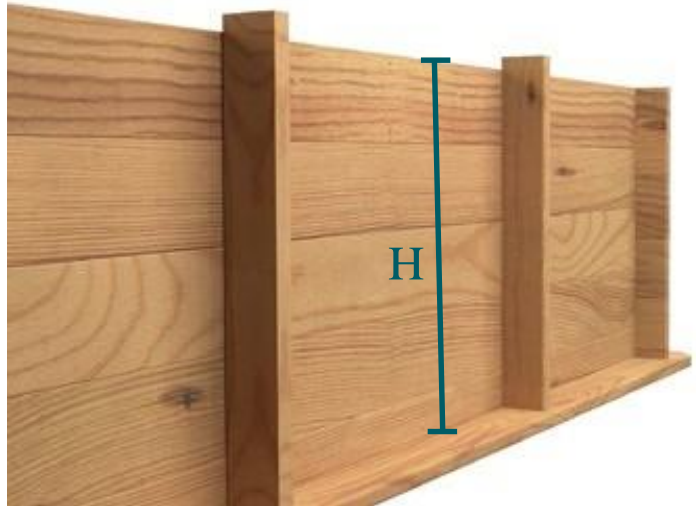

208 ×6

6 (634x86x58):

(203).



H 2,8
6

H

6

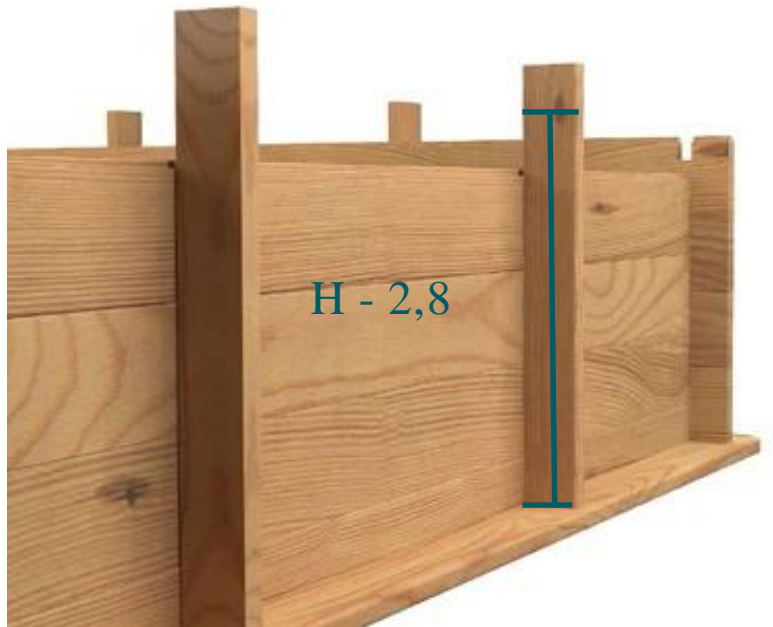

209 ×2

2 (535x86x58):

(200)
(203).



H 12,7

2





102 ×12



205 ×3
102 ×15



(102):

(205)

(203)

(205)

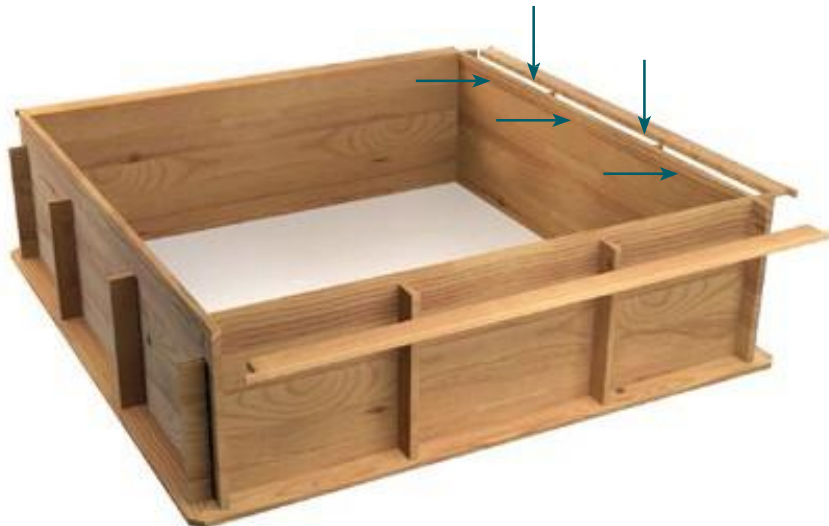



207	×1
102	×7

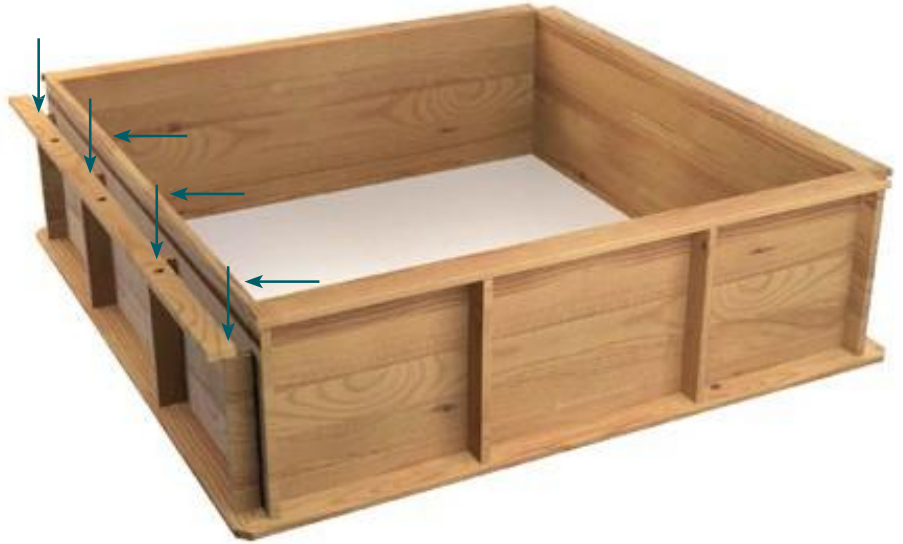

(203)

(207)

(207),

102	×4
-----	----

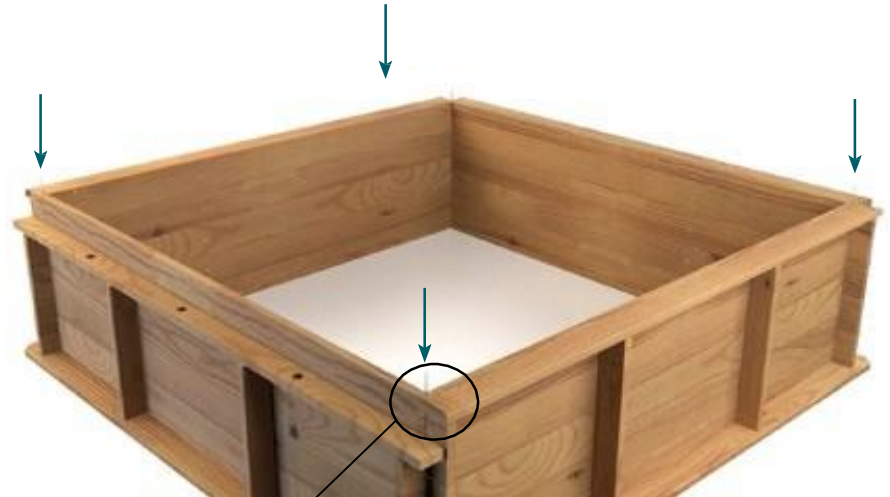

(102).

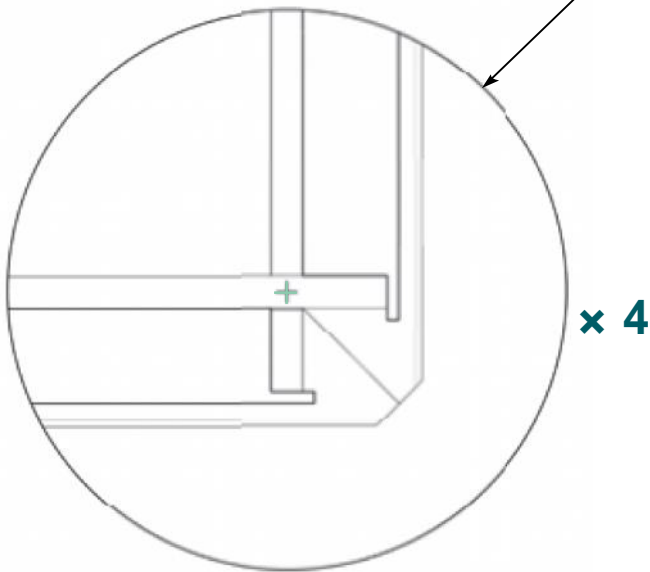

III-2



403	×2
104	×8

400	×1
103	×3

405	×1
-----	----

400	×1
103	×3

PISTOCHE

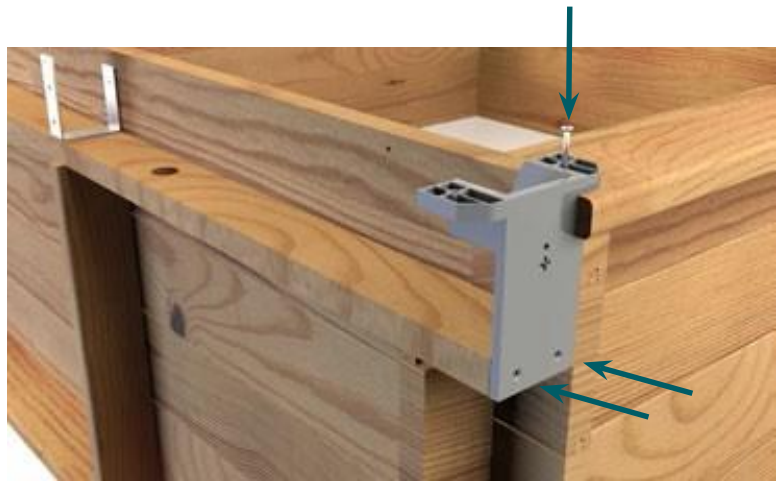



(403)

(104)

206	×1
102	×4
103	×2
104	×2

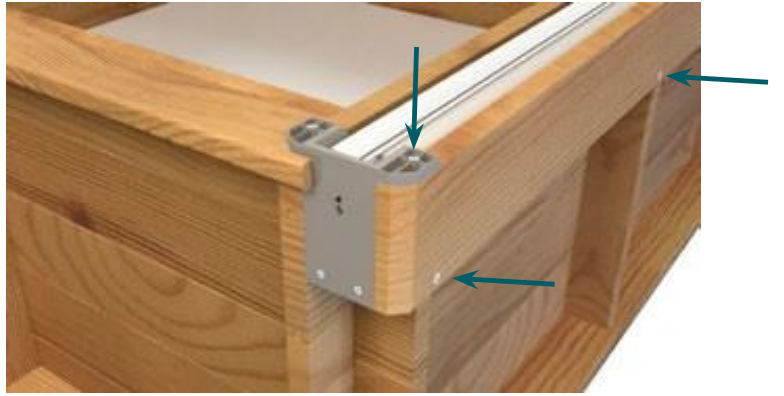

210	×6
211	×2
101	×24



15-

214	×6
105	×18

_____ :

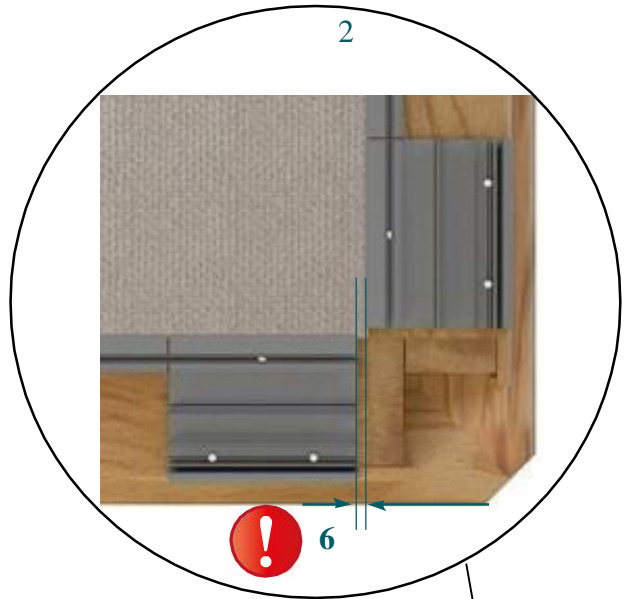
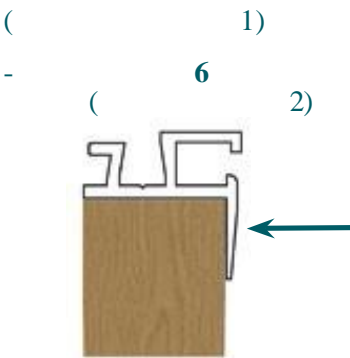

213	×3
105	×12

168,8-

_____ :

(1)
- 15



215	×1
216	×1
105	×8

107

(400).

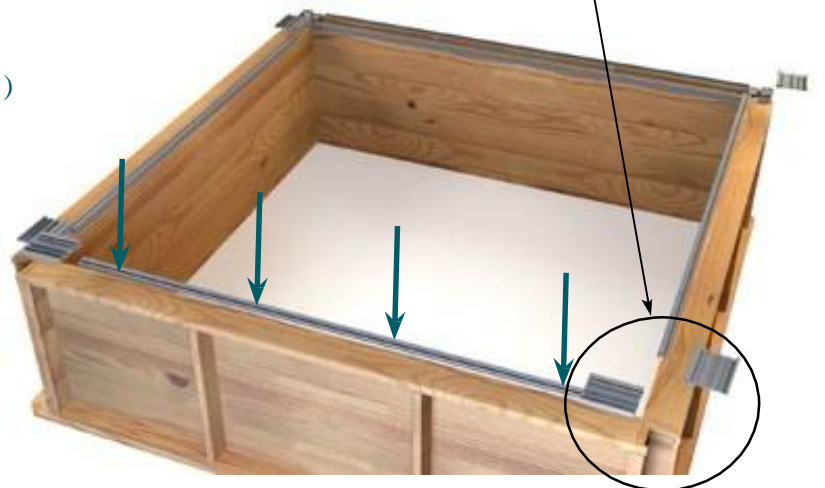

III-3



_____ :

212	×1
217	×1
219	×2
105	×14

(217)



(212),

()

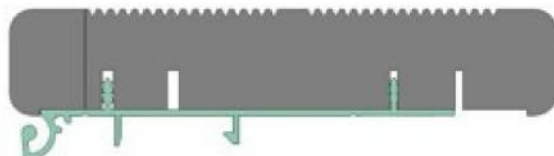

(219).



_____ :



(212), (217),



()

212	×1
217	×1
105	×8

_____ : Просверлите отверстия в алюминиевой полосе (217) согласно схеме ниже.



212	×2
217	×2
105	×16

_____ : Просверлите отверстия в алюминиевой полосе (217) согласно схеме ниже.

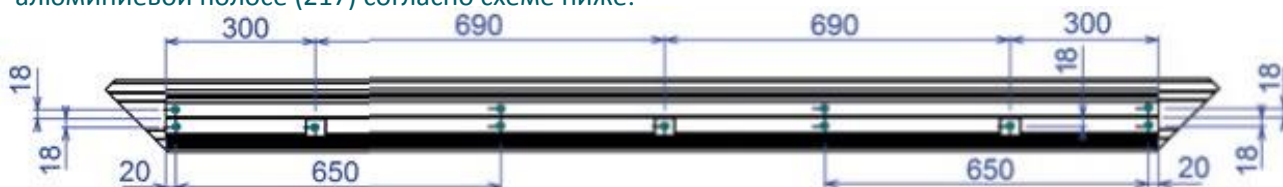

404	×6
104	×6

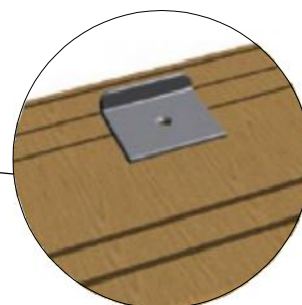



402	×8
105	×8



III-4

0,5



218	×1
500	×1



(213 216)



500	×1
-----	----

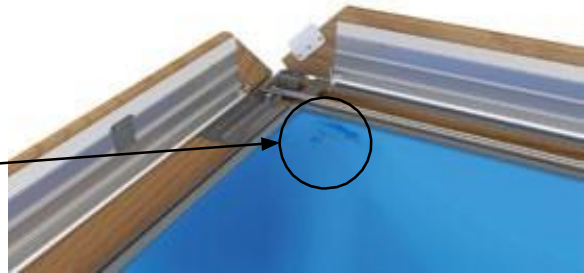

40 58



(24).

III-5

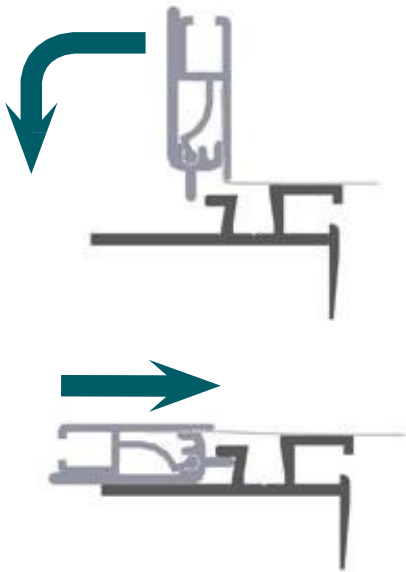

401	x2
104	x2

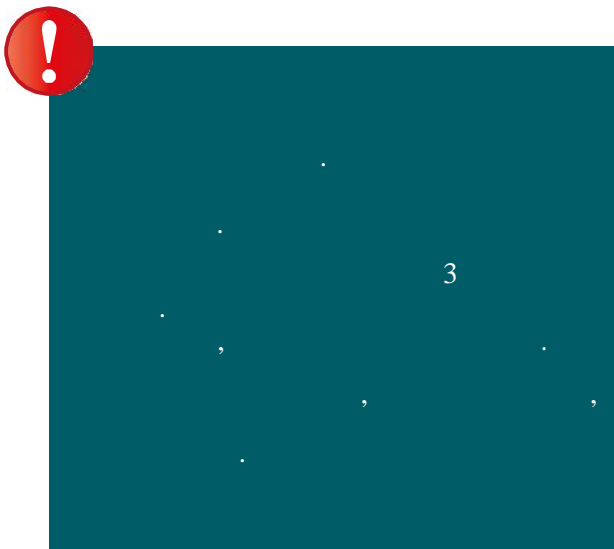
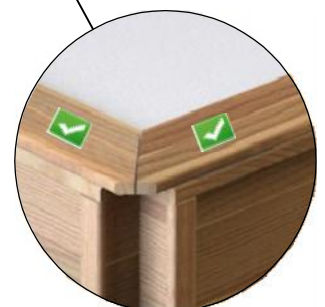

3



(213),

Pistoche.



III-6

- 301 ×1
- 302 ×1

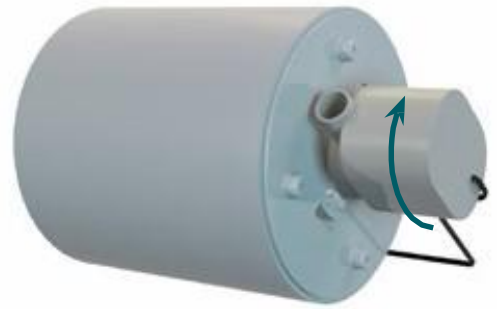
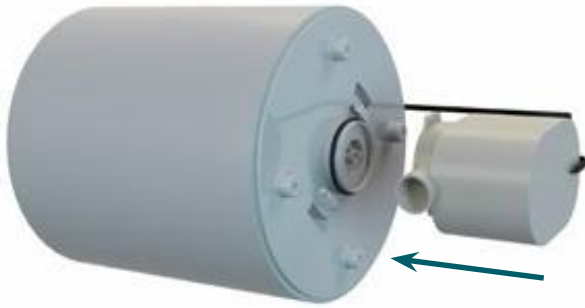

- 300 ×1
- 105 ×4



- 303 ×1

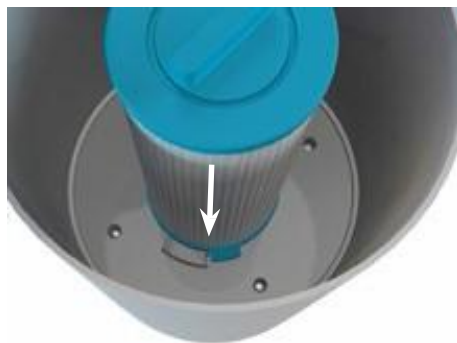

304	×1
105	×2

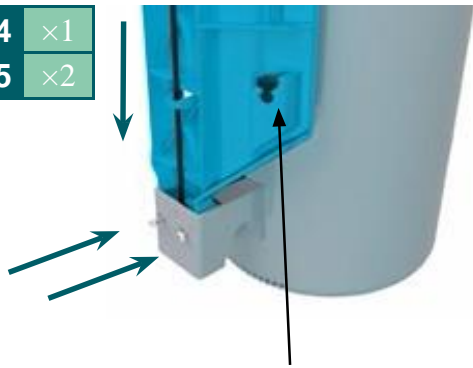

2

305	×1
307	×1



306	×1
308	×1
309	×4



(308)
(306).

(309)

4

(306)



40



50



58

IX.1

- 1) (; 3)
- 2) ; 4) 20
- 3) ;
- 4) ;
- 5) ;

IX.2

4





